

Art. Nr. 3418896  
1/7



30.10.2023

Art. Nr. 3418896

Groundplan - Grundplan - Plan de masse - Planimetria - Plattegrond - Põhiplaan

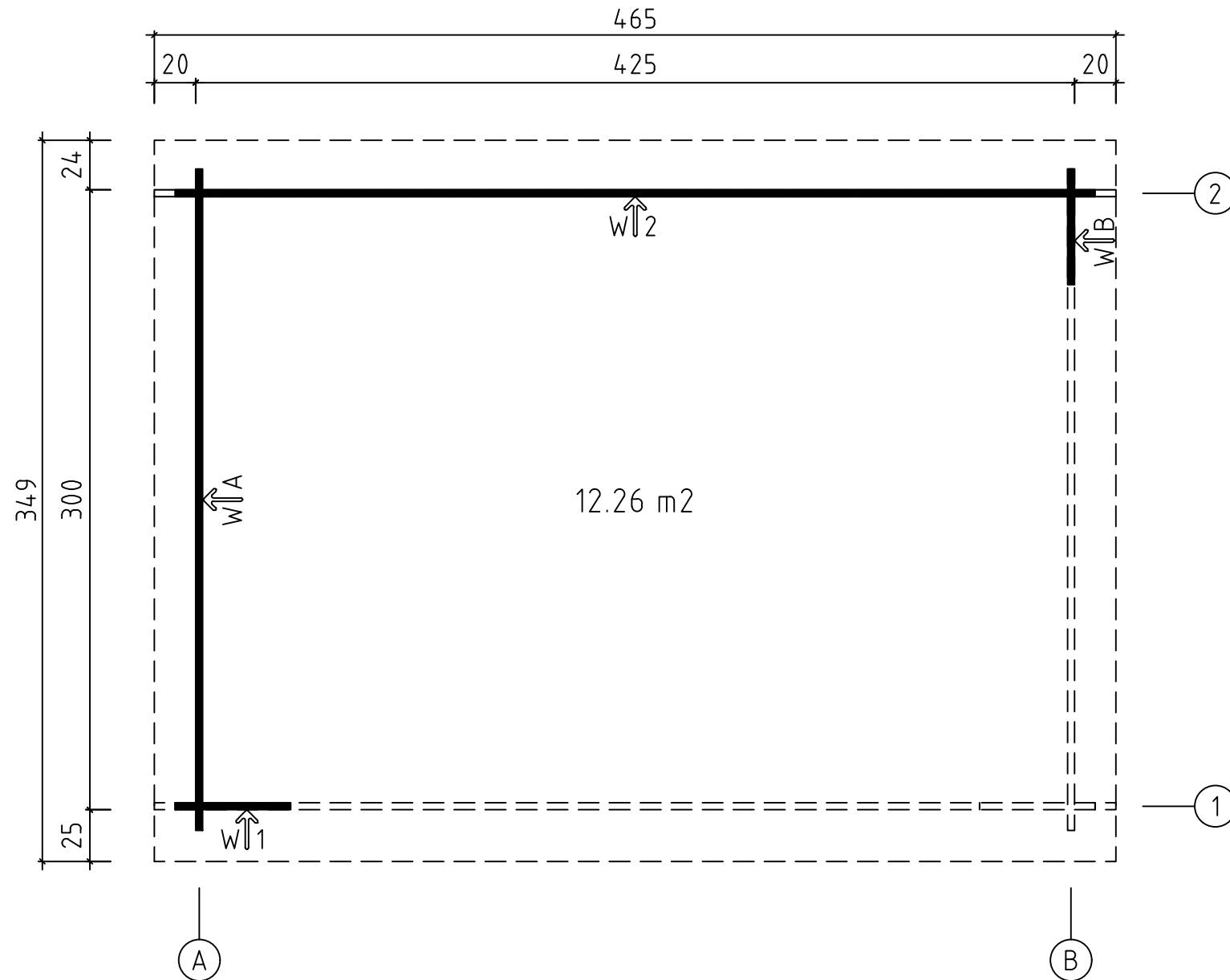

30.10.2023



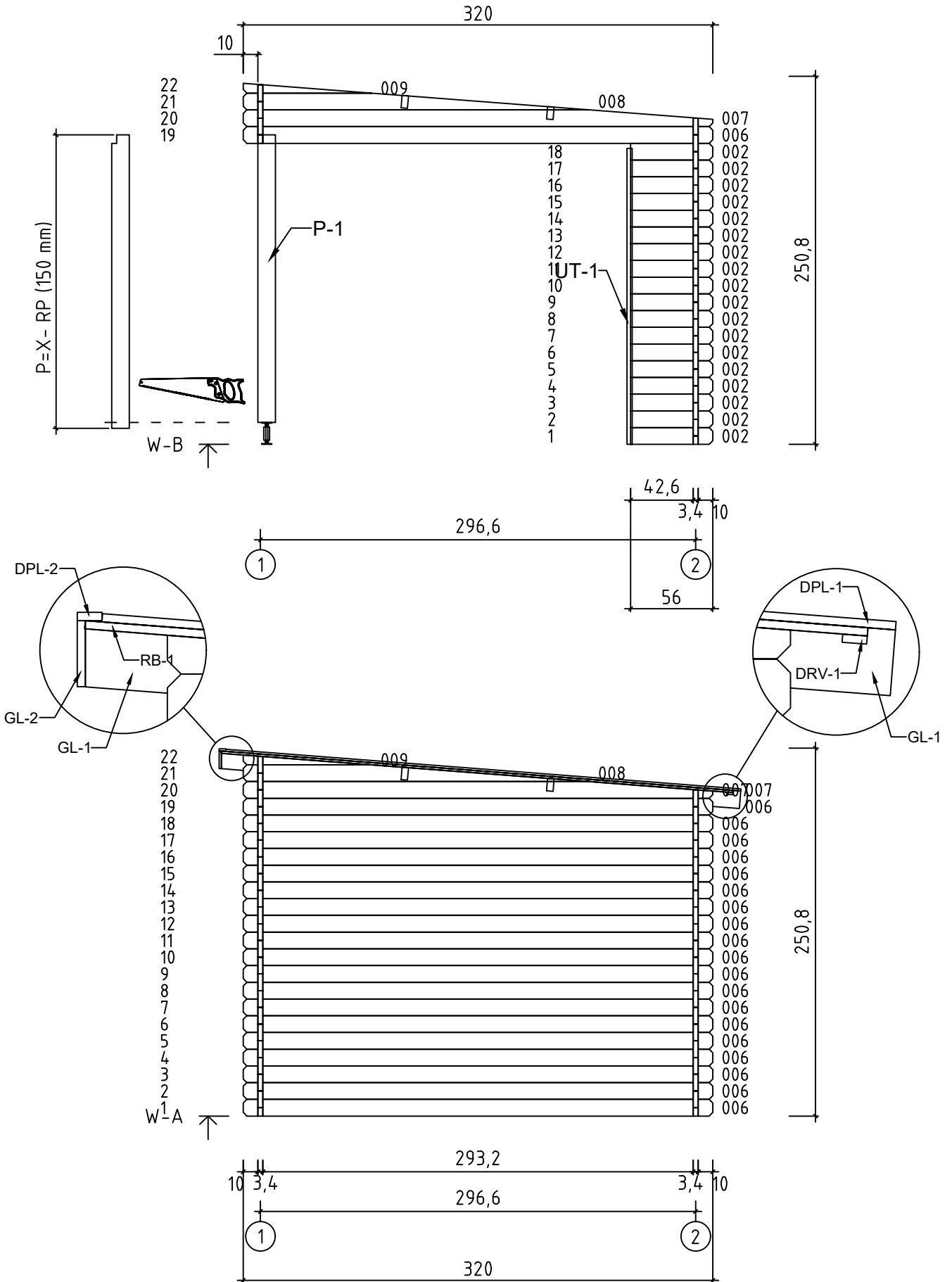



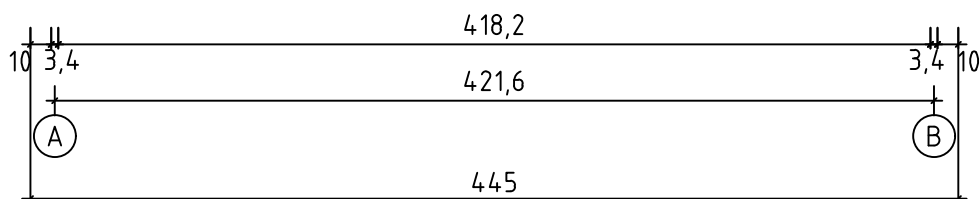
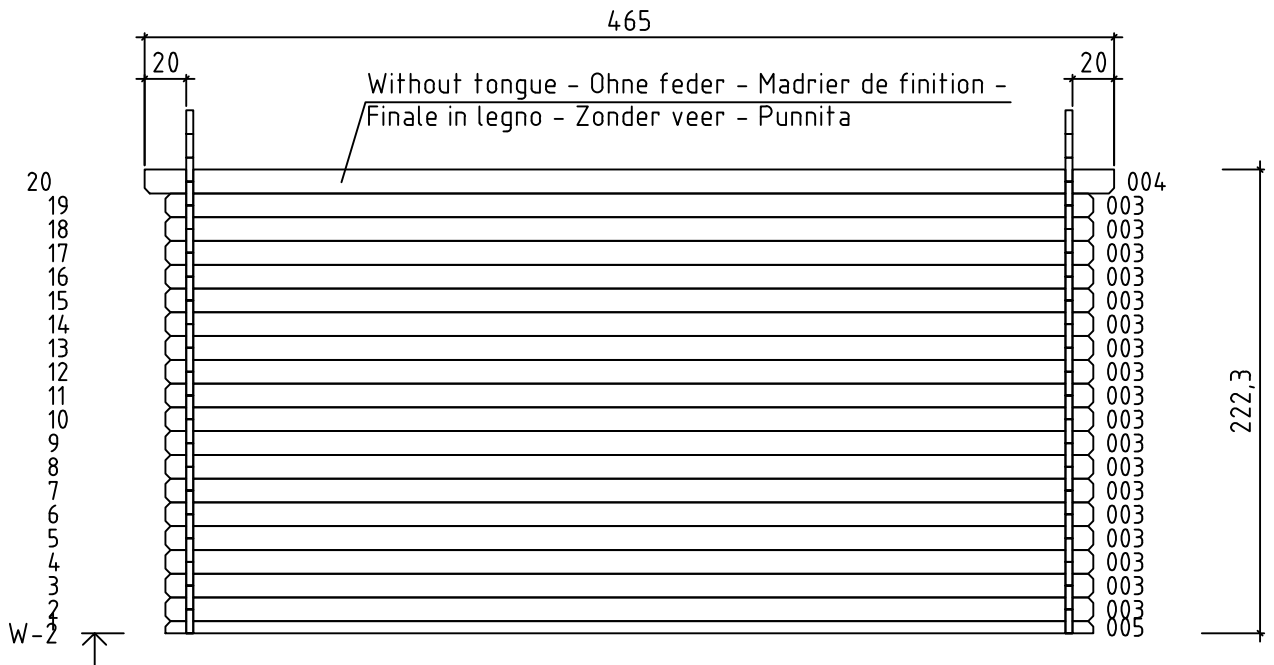
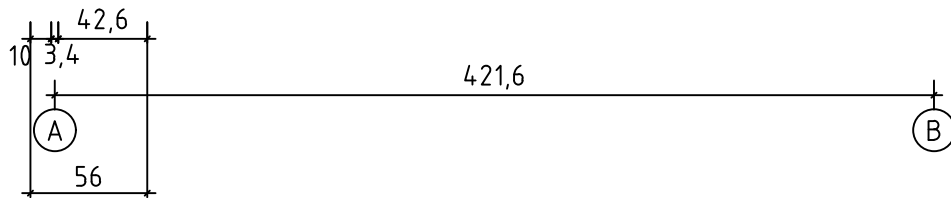
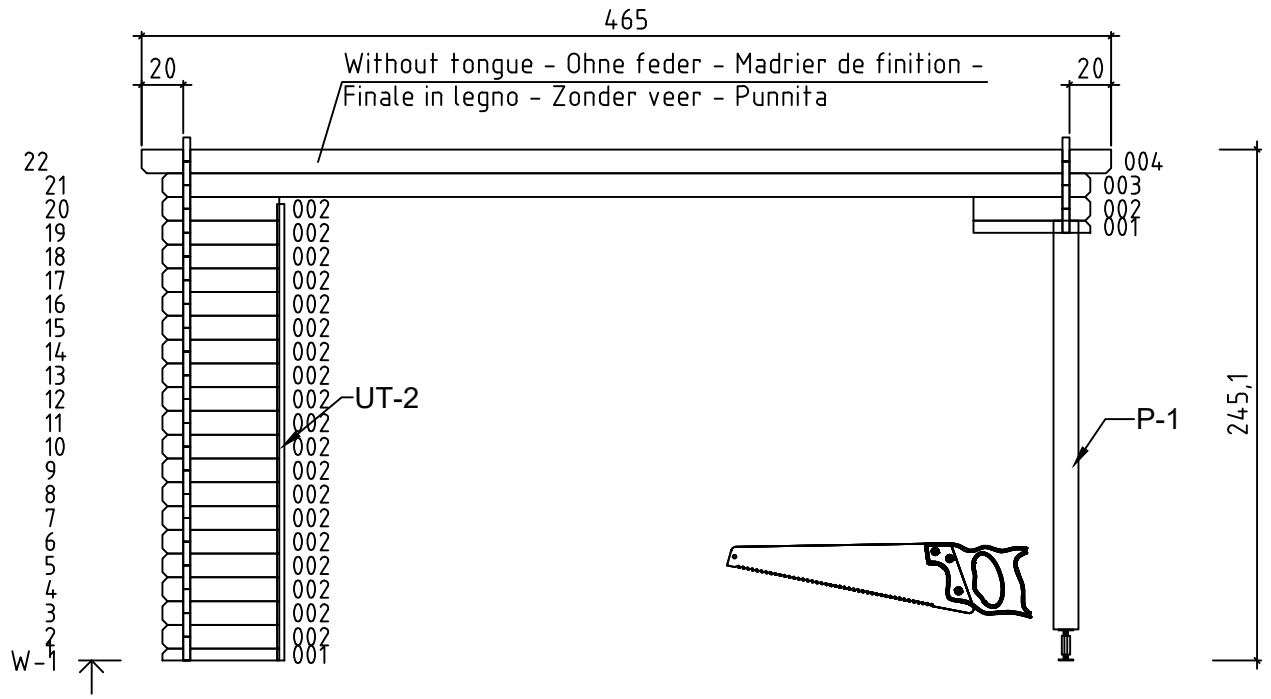

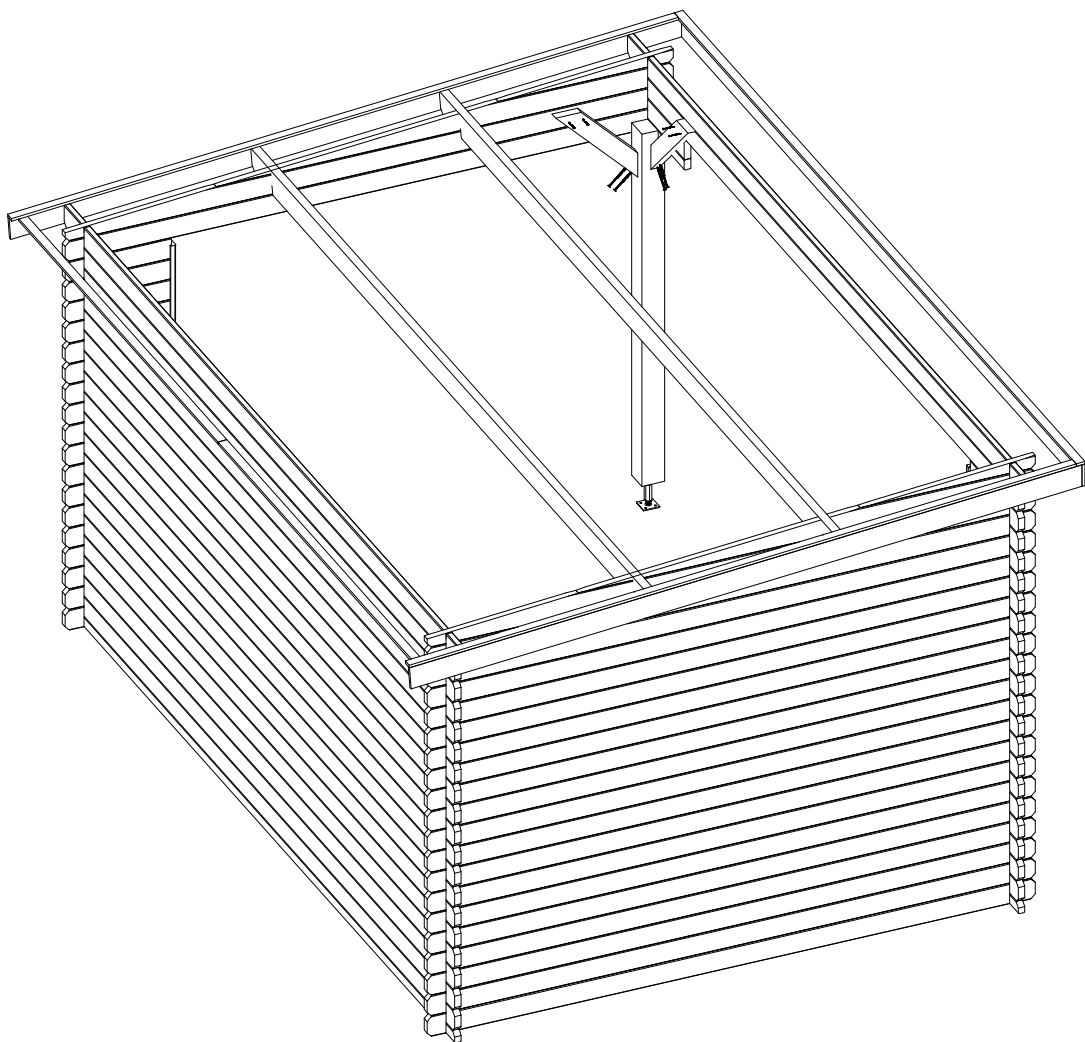
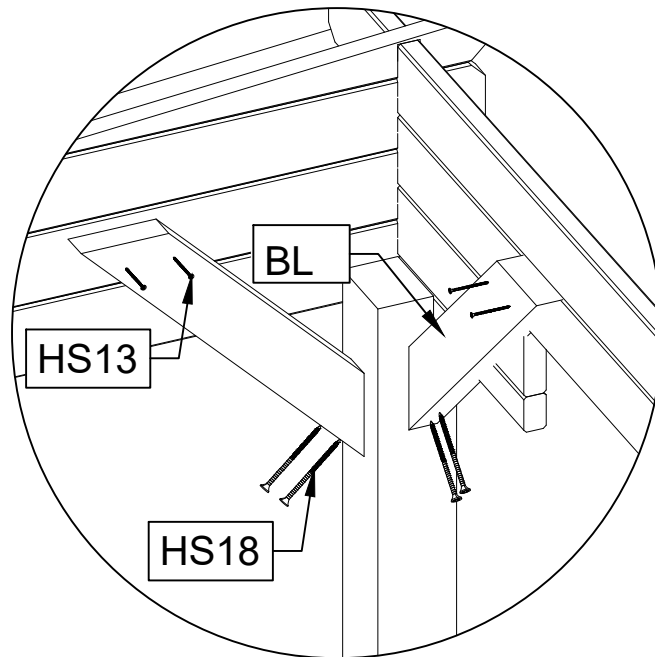
2/7

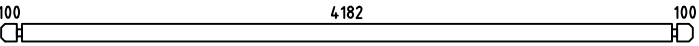
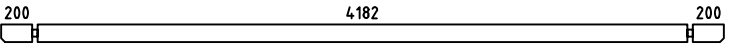
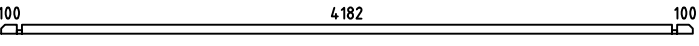
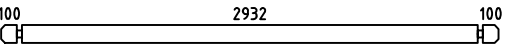
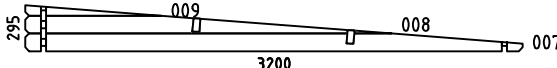
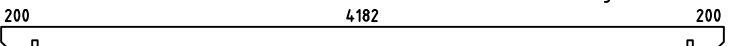
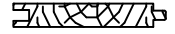
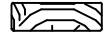

Art. Nr. 3418896

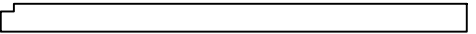
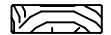
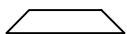
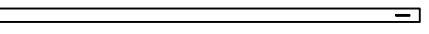
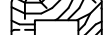
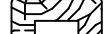
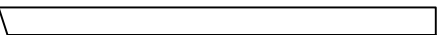
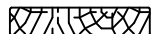



| Pos                   | 30.10.2023 Piece list - Stückliste - Liste des pièces - Elementi - Stuklijst - Tükítabel<br>Art. Nr. 3418896 6/7  | Q      | P<br>(mm) | L<br>(mm) |
|-----------------------|---|--------|-----------|-----------|
| 001<br>37581          |    | 2      | 34x57     | 560       |
| 002<br>37582          |    | 38     | 34x114    | 560       |
| 003<br>37583          |   | 19     | 34x114    | 4450      |
| 004                   |   | 2      | 34x114    | 4650      |
| 005<br>37591          |   | 1      | 34x57     | 4450      |
| 006<br>14.76          |    | 20     | 34x114    | 3200      |
| WA-1<br>WB-1<br>37592 |   | 1<br>1 |           |           |
| A-PR1<br>37593        | Roof beam - Dachbalken - Panne de toit - Perlina del tetto - Gordingen / dakbalk - Pärilin<br>  | 2      | 44x146    | 4650      |
| RB-1<br>31647         | Roof boards - Dachbretter - Voliges - Perlina per tetto - Dakhout - Katuselaud   | 52     | 90x15.5   | 3500      |
| DPL-1<br>32729        | Roofing felt fillet - Dachpappenleiste - Baguette de fixation du feutre bitumeux - Asse per fissaggio guaina bituminosa - Afdeklijst asfaltpapier - Katusepapiilist   | 2      | 15x45     | 3520      |
| DPL-2<br>37594        | Roofing felt fillet - Dachpappenleiste - Baguette de fixation du feutre bitumeux - Asse per fissaggio guaina bituminosa - Afdeklijst asfaltpapier - Katusepapiilist    | 1      | 15x45     | 4680      |
| P-1<br>34797          | Post - Pfosten - Poteau - Piede registrabile - Stijl - Post   | 1      | 120x120   | 2000      |
| DRV-1<br>34165        | Roof edge reinforcement - Dachrandverstärkung - Corniere de renfort de bord de toit - Rinforzo x tetto - Dakrand versterking - Räästatugevdus    | 2      | 15x45     | 2325      |
| BL<br>34799           | Beam - Balkenlage - Solive(s) - Trave - Balk (gording) - Tala    | 2      | 44x120    | 620       |
| KFS-1<br>27180        | Storm protection - Sturmleiste - Latte anti-tempete - Protezione anti vento - Stormverankering / beveiliging - Tormikinnitusliist   | 3      | 22x45     | 2500      |
| UT-1<br>34798         | U-profile - U-profils - Profile u - Profilo ad u - U-profiel - U-profiil   | 1      | 35x70     | 2017      |
| UT-2<br>40980         | U-profile - U-profils - Profile u - Profilo ad u - U-profiel - U-profiil   | 1      | 35x70     | 2190      |
| GL-1<br>37596         | Gable moulding - Giebelleiste - Planche de rive - Finitura per frontale e retro del tetto - Gevellijst - Viilulaud    | 2      | 15x120    | 3550      |
| GL-2<br>37597         | Gable moulding - Giebelleiste - Planche de rive - Finitura per frontale e retro del tetto - Gevellijst - Viilulaud   | 1      | 15x120    | 4680      |
| HS9<br>5106           | Screw for u-profile - Schraube zur befestigung u-profils - Vis a tete fraisée pour profil u - Vite per profilo ad u - Schroef ter bevestiging u-profiel - Kruvi U-profiilile   | 12     | 3.5x50    |           |
| HS9<br>5106           | Screw for gable moulding - Schrauben für giebelleiste - Vis pour fixation planche de rive - Vite per fissare finiture davanti e dietro del tetto - Schroef voor gevellijst - Kruvi viilulauale                         | 30     | 3.5x50    |           |
| HS4<br>5102           | Screw for roof edge reinforcement - Schrauben für dachrandverstärkung - Vis pour fixation corniere renfort de bord de toit - Viti x rinforzo bordo tetto - Schroef voor dakrand versterking - Kruvi räästatugevdusele  | 12     | 3x30      |           |
| HS13<br>5110          | Screw for beam - Schrauben zur befestigung dachsparren - Vis pour solive (s) - Viti per perline - Schroef voor balk (gording) - Kruvi talale   | 4      | 4x60      |           |

